



## **CÔNG TY TNHH THANG MÁY VHM VIỆT NAM**

Địa chỉ : L3.8, Liên kê Hải Ngân, Thôn Thượng, Thanh Liệt,  
Huyện Thanh Trì, TP. Hà Nội, Việt Nam

Điện thoại : 0352 298 822

Email : [Sales.thangmayvhm@gmail.com](mailto:Sales.thangmayvhm@gmail.com)

Website : [WWW.thangmayvhm.com.vn](http://WWW.thangmayvhm.com.vn)



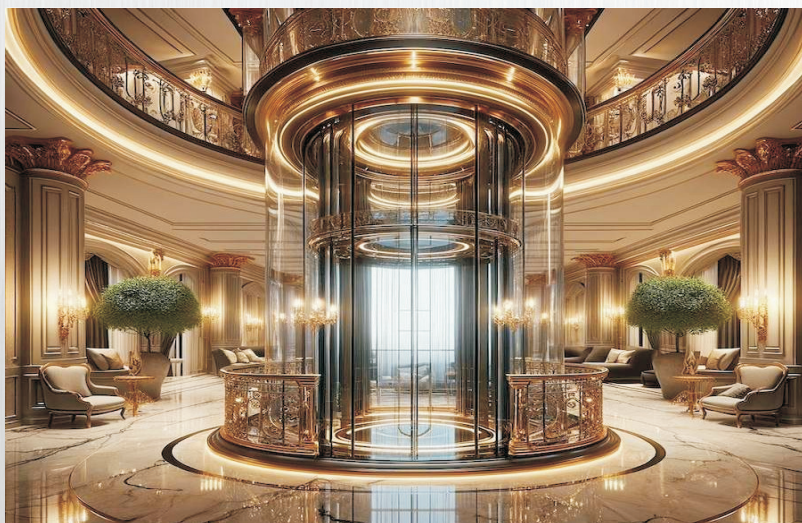

## LỜI GIỚI THIỆU

**Công ty TNHH Thang Máy VHM Việt Nam** chúng tôi là đơn vị chuyên: lắp đặt thang máy hàng đầu trên thị trường Việt Nam. Với đội ngũ lãnh đạo, quản lý sản xuất trên 10 năm kinh nghiệm và độ ngũ kỹ thuật viên dày dặn kinh nghiệm, chúng tôi tự tin sẽ đáp ứng được tốt nhất những yêu cầu của quý khách hàng đặt ra.

- \* Thiết kế, lắp đặt các hệ thống thang máy
- \* Cung cấp lắp đặt thang cuốn (Escalators)
- \* Cung cấp lắp đặt thang máy tải khách ( Passenger Elevators)
- \* Cung cấp lắp đặt thang máy cho bệnh viện ( Hospital Elevator)
- \* Cung cấp lắp đặt thang máy Lồng Kính (Panoramic Elevator)
- \* Cung cấp lắp đặt thang máy tải Xe Hơi (Car Elevator)
- \* Cung cấp lắp đặt thang máy tải hàng cho nhà xưởng (Freight Elevator)
- \* Cung cấp lắp đặt thang máy tải thực phẩm cho nhà hàng, khách sạn (Food Elevator)
- \* Cung cấp lắp đặt thang máy gia đình (Home lift)
- \* Cung cấp các Phụ kiện thang máy (Eccessories)
- \* Cung cấp lắp đặt các thiết bị nâng, băng truyền tải (lifting equipment, conveyor)
- \* Cung cấp lắp đặt thang máy thủy lực (Hydraulic)

**Thang máy VHM** tư vấn thiết kế, xây dựng, hỗ trợ bản vẽ thiết kế các loại thang máy.

### **CAM KẾT:**

**1/ AN TOÀN:** Sản phẩm được bảo đảm về chất lượng, đáp ứng các tiêu chí an toàn cho người sử dụng. Khách hàng được hướng dẫn sử dụng chi tiết tận tình; bên cạnh đó các sản phẩm được bảo trì, bảo dưỡng định kì.

**2/ TẬN DỤNG KHÔNG GIAN:** tư vấn, thiết kế tận dụng tối đa kích thước để mang đến sản phẩm phù hợp với kích thước không gian của khách hàng.

**3/ THẨM MỸ:** Sản phẩm thể hiện sự hoàn hảo, đáp ứng các yêu cầu về thẩm mỹ.

**4/ SỰ HÀI LÒNG:** luôn lắng nghe ý kiến của khách hàng và mang đến những sản phẩm đạt sự hài lòng tối đa nhất.

### **LỜI KẾT**

**Thang máy VHM** chân thành cảm ơn quý khách đã quan tâm và đang ủng hộ chúng tôi. Chúng tôi mong được phục vụ quý khách và mong nhận được nhiều ý kiến đóng góp để phát triển.

- Hãy liên hệ với chúng tôi ngay tại số hotline: **0352 298 822** để được tư vấn ngay.



## SƠ ĐỒ THANG TẢI KHÁCH CÓ PHÒNG MÁY

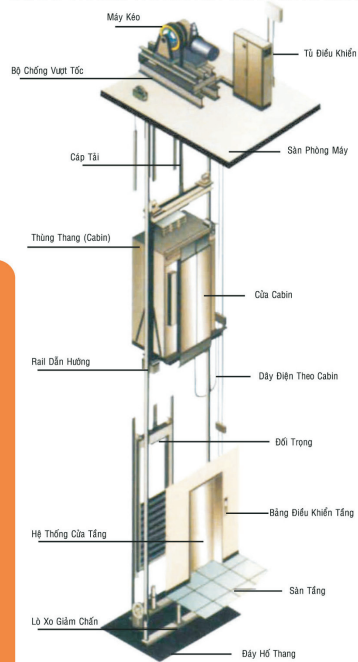

Chi Tiết Móc Treo

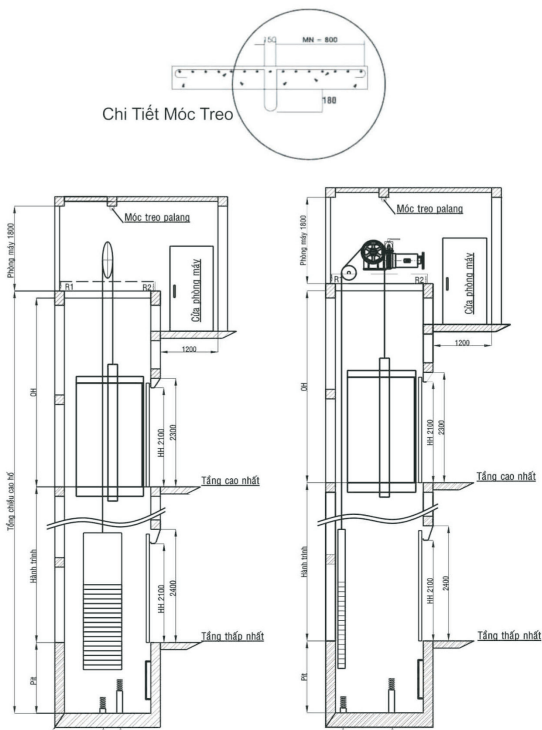

THANG TẢI KHÁCH ĐỐI TRỌNG PHÍA SAU

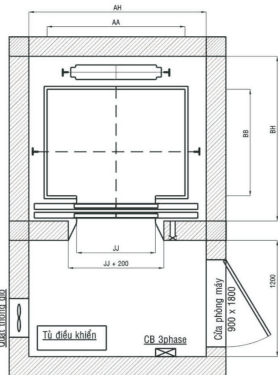

THANG TẢI KHÁCH ĐỐI TRỌNG BÊN HÔNG

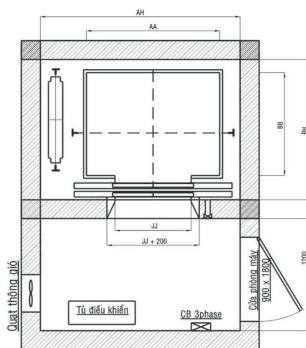

## ĐỐI TRỌNG ĐẶT PHÍA SAU

Mã hiệu	Tải trọng		Tốc độ (m/phút)	Cửa mở Rộng x Cao (JJ x H)	Cabin Rộng x sâu (AA x BB)	Hố thang		
	Kg	Người				Rộng x Sâu (AH x BH)	Chiều cao OH	Chiều sâu PIT
P4	300	4	60	700x2100	1100x900	1500x1500	4000	1400
			90	700x2100	1100x1000	1500x1600	4200	1500
P6	450	6	60	700x2100	1200x1000	1600x1500	4000	1400
			90	750x2100	1300x1000	1700x1600	4200	1500
				800x2100	1400x900	1800x1500		
P8	600	8	60	800x2100	1400x1100	1800x1700	4200	1500
			90	850x2100	1400x1200	1800x1800	4500	1600
				900x2100	1400x1300	1900x1900		
P10	750	10	60	800x2100	1400x1100	1800x1700	4200	1500
			90	850x2100	1400x1200	1800x1800	4500	1600
P15	1000	15	60	900x2100	1400x1350	1900x2000	4200	1600
				900x2100	1600x1500	2000x2100		
			90	1000x2100	1700x1600	2100x2200	4500	1600
P20	1500	20	60	1000x2100	1800x1700	2200x2400	4300	1600
				1100x2100	1800x1800	2300x2500		
			90	1200x2100	1900x1900	2400x2600	4500	1600

## ĐỐI TRỌNG ĐẶT BÊN HÔNG

Mã hiệu	Tải trọng		Tốc độ (m/phút)	Cửa mở Rộng x Cao (JJ x H)	Cabin Rộng x sâu (AA x BB)	Hố thang		
	Kg	Người				Rộng x Sâu (AH x BH)	Chiều cao OH	Chiều sâu PIT
P4	300	4	60	700x2100	1100x900	1800x1250	4000	1400
			90	700x2100	1100x1000	1800x1350	4200	1500
P6	450	6	60	700x2100	1200x1000	1900x1350	4000	1400
				750x2100	1400x900	2100x1350		
			90	800x2100	1400x1000	2100x1450	4200	1500
P8	600	8	60	800x2100	1400x1100	2100x1450	4200	1500
				850x2100	1400x1200	2100x1550		
			90	900x2100	1400x1300	2100x1650	4500	1600
P10	750	10	60	800x2100	1400x1100	2100x1450	4200	1500
				850x2100	1400x1200	2100x1550		
			90	900x2100	1400x1300	2100x1650	4500	1600
P15	1000	15	60	900x2100	1600x1500	2400x1850	4200	1500
				950x2100	1700x1600	2500x1950		
			90	1000x2100	1800x1700	2600x2050	4500	1600
P20	1500	20	60	1000x2100	1800x1800	2600x2200	4300	1600
				1100x2100	1900x1900	2700x2300		
			90	1200x2100	1900x1900	2800x2400	4500	1600



# HỆ THỐNG THANG TẢI KHÁCH LOẠI KHÔNG CÓ PHÒNG MÁY



SƠ ĐỒ THANG TẢI KHÁCH KHÔNG PHÒNG MÁY

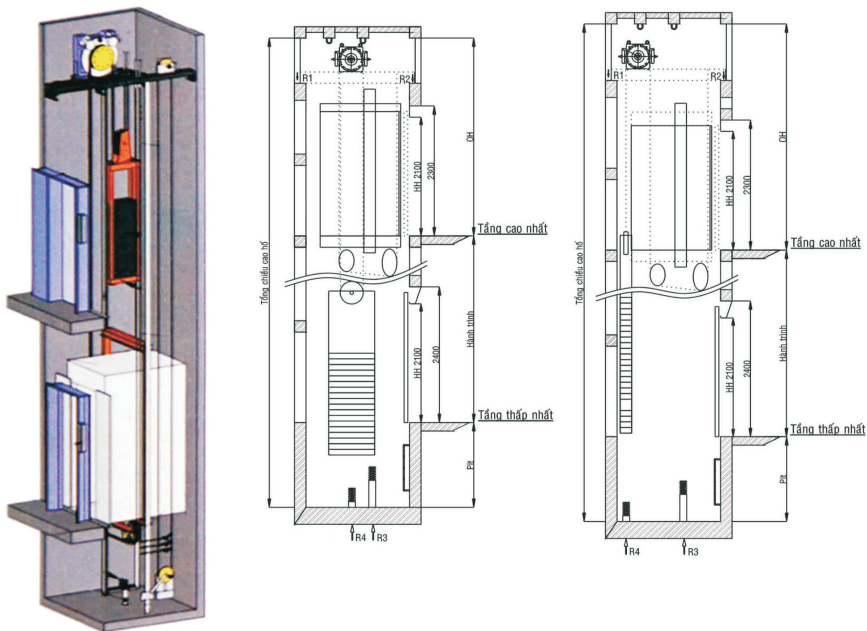

THANG TẢI KHÁCH ĐỐI TRỌNG PHÍA SAU

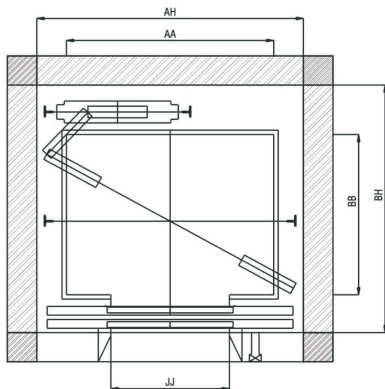

THANG TẢI KHÁCH ĐỐI TRỌNG BÊN HÔNG

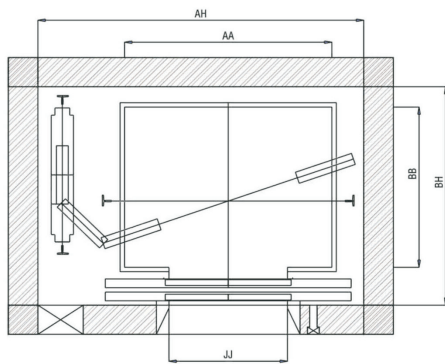

# BẢNG TIÊU CHUẨN KỸ THUẬT THANG TẢI KHÁCH KHÔNG PHÒNG MÁY



## ĐỐI TRỌNG ĐẶT PHÍA SAU

Mã hiệu	Tải trọng		Tốc độ (m/phút)	Cửa mở Rộng x Cao (JJ x H)	Cabin Rộng x sâu (AA x BB)	Hố thang			
	Kg	Người				Rộng x Sâu (AH x BH)	Chiều cao OH	Chiều sâu PIT	
P4	300	4	60	700x2100	1100x900	1500x1500	3800	1400	
			90	1100x1000	1500x1600	3900	1500		
P6	450	6	60	700x2100	1200x1000	1600x1500	3800	1400	
			90	750x2100	1300x1000	1700x1600	3900	1500	
				800x2100	1400x900	1800x1500			
P8	600	8	60	800x2100	1400x1100	1800x1700	4000	1500	
			90	850x2100	1400x1200	1800x1800	4200	1600	
				900x2100	1400x1300	1900x1900			
P10	750	10	60	800x2100	1400x1100	1800x1700	4000	1500	
			90	850x2100	1400x1200	1800x1800	4200	1600	
				900x2100	1400x1350	1900x2000			
P15	1000	15	90	900x2100	1600x1500	2000x2100	4200	1500	
				950x2100	1700x1600	2100x2200	4400	1600	
				1000x2100	1800x1700	2200x2400			
P20	1500	20	60	1000x2100	1800x1800	2300x2500	4300	1600	
				90	1100x2100	1900x1900	2400x2600	4500	1600
					1200x2100	2000x2000	2500x2700		

## ĐỐI TRỌNG ĐẶT BÊN HÔNG

Mã hiệu	Tải trọng		Tốc độ (m/phút)	Cửa mở Rộng x Cao (JJ x H)	Cabin Rộng x sâu (AA x BB)	Hố thang			
	Kg	Người				Rộng x Sâu (AH x BH)	Chiều cao OH	Chiều sâu PIT	
P4	300	4	60	700x2100	1100x900	1800x1250	3500	1400	
			90	1100x1000	1800x1350	3600	1500		
P6	450	6	60	700x2100	1200x1000	1900x1350	3600	1400	
			90	750x2100	1300x1000	2000x1350	3700	1500	
				800x2100	1400x900	2100x1250			
P8	600	8	60	800x2100	1400x1100	2100x1450	3700	1500	
			90	850x2100	1400x1200	2100x1550	3900	1600	
				900x2100	1400x1300	2100x1650			
P10	750	10	60	800x2100	1400x1100	2100x1450	3700	1500	
				90	850x2100	1400x1200	2100x1550	3900	1600
					900x2100	1400x1350	2200x1700		
P15	1000	15	60	900x2100	1600x1500	2400x1850	3900	1500	
				90	950x2100	1700x1600	2500x1950	4100	1600
					1000x2100	1800x1700	2600x2050		
P20	1500	20	60	1000x2100	1800x1800	2600x2200	4100	1600	
				90	1100x2100	1900x1900	2700x2300	4200	1600
					1200x2100	2000x2000	2800x2400		

Hotline: 0352 298 822

Hotline: 0352 298 822



# HỆ THỐNG THANG HOMELIFT



# HỆ THỐNG THANG HOMELIFT LOẠI CỬA MỞ TỰ ĐỘNG (OH:3200; PIT:300)



## SƠ ĐỒ KHUNG THANG HOMELIFT

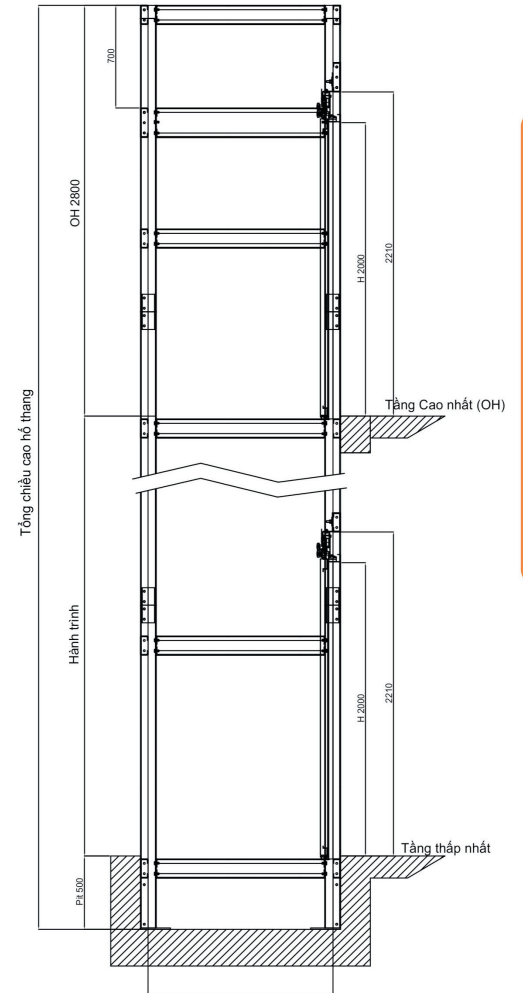

Hotline: 0352 298 822



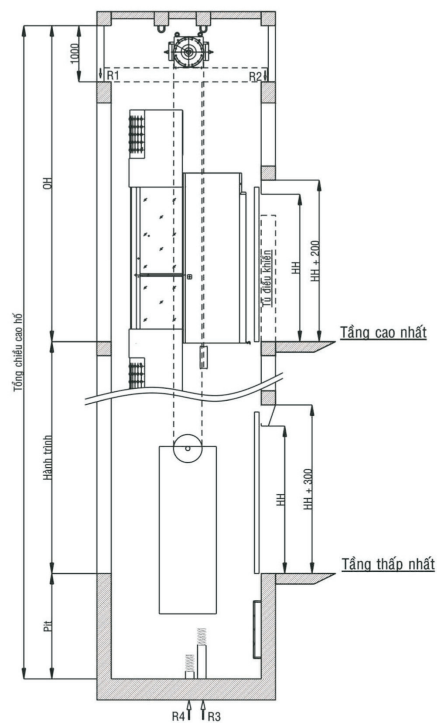

THANG KHÔNG PHÒNG MÁY

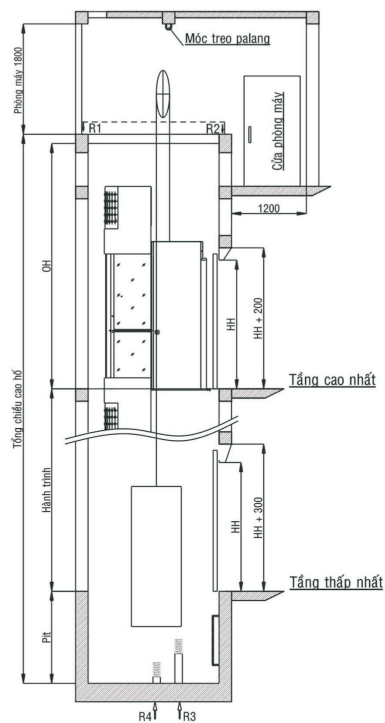
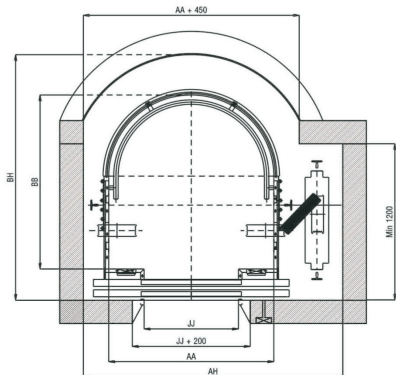

THANG CÓ PHÒNG MÁY

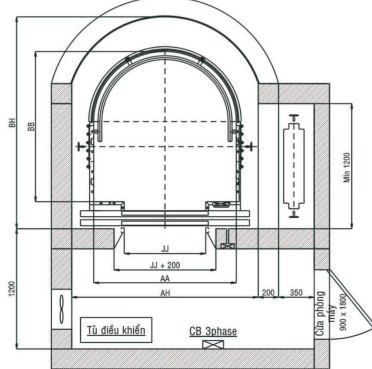

CÁC LOẠI THANG LỒNG KÍNH

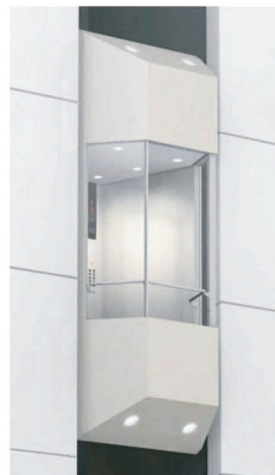

HS-LK01



HS-LK02



HS-LK03



HS-LK04



HS-LK05

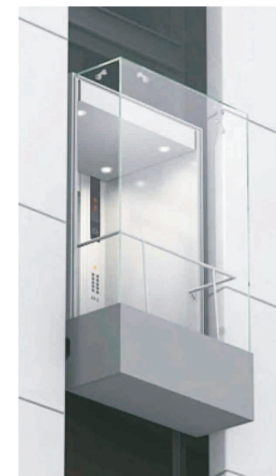

HS-LK06





HS-LK07



HS-LK08



HS-LK09

**BẢNG TIÊU CHUẨN KỸ THUẬT**

**BẢNG TIÊU CHUẨN KỸ THUẬT THANG LỒNG KÍNH CÓ PHÒNG MÁY**

MÃ HIỆU	TẢI TRỌNG Kg	NGƯỜI	TỐC ĐỘ m/phút	KÍCH THƯỚC (mm)			
				Cửa mở JJ x HH	Cabin AA x BB	Hố thang AH x BH	OH/Pit
P8	600	8	60	700 x 2100	1200 x 1200	1650 x 1800	4200/1500
			90				4400/1600
P10	750	10	60	800 x 2100	1400 x 1350	1850 x 2000	4200/1500
			90				4400/1600
P15	1000	15	60	800 x 2100	1400 x 1500	1850 x 2100	4200/1500
			90				4400/1600

**BẢNG TIÊU CHUẨN KỸ THUẬT THANG LỒNG KÍNH KHÔNG PHÒNG MÁY**

MÃ HIỆU	TẢI TRỌNG Kg	NGƯỜI	TỐC ĐỘ m/phút	KÍCH THƯỚC (mm)			
				Cửa mở JJ x HH	Cabin AA x BB	Hố thang AH x BH	OH/Pit
P8	600	8	60	700 x 2100	1200 x 1200	2000 x 1800	4600/1500
			90				4800/1600
P10	750	10	60	800 x 2100	1400 x 1350	2200 x 2000	4600/1500
			90				4800/1600
P15	1000	15	60	800 x 2100	1400 x 1500	2200 x 2100	4600/1500
			90				4800/1600



Thang máy tải Thực Phẩm VINATECH là phù hợp nhất cho việc vận chuyển các đồ dùng của nhà bếp, các loại thức ăn, thức uống trong các Nhà Hàng, Khách Sạn, những vật dụng hàng hóa đơn giản trong các Siêu Thị, Trung Tâm Thương Mại, những vật dụng đơn giản như Hồ Sơ, Sách, Báo trong các Ngân Hàng, Thư Viện, Văn Phòng, v.v...



\* Sản xuất theo nhu cầu sử dụng của các Khách Hàng về tải trọng, kích thước, tốc độ...





THANG TẢI Ô TÔ



CỬA MỞ TİM 4 CÁNH



Cabin: Toàn bộ inox sọc nhuyễn  
HS-CB01



Cabin: Tấm lớn ở giữa inox gương  
xen inox sọc nhuyễn hai bên  
HS-CB02



Cabin: Tấm lớn ở giữa inox gương hoa văn  
xen inox gương hai bên  
HS-CB03



Cabin: Tấm lớn ở giữa inox gương hoa văn  
xen inox gương hai bên  
HS-CB04

Hotline: 0352 298 822

Hotline: 0352 298 822





HS-CB05



HS-CB06



HS-CB09



HS-CB10



HS-CB07



HS-CB08



HS-CB11



HS-CB12

Hotline: 0352 298 822

Hotline: 0352 298 822



**MẪU HOA VĂN CỬA TẦNG**  
(LOẠI VẬT LIỆU INOX KHÁCH HÀNG TÙY CHỌN)



HS - 1A

HS - 1B

HS - 1C

HS - 1D



HS - 2A

HS - 2B

HS - 2C

HS - 2D

**GHI CHÚ:** INOX SỌC NHUYỄN / INOX GƯƠNG => Màu trắng, màu vàng, màu đồng  
(Inox màu nào ăn mòn màu đó)  
\* Phần màu xám là vật liệu  
\* Phần màu trắng là vị trí ăn mòn

**MẪU HOA VĂN CỬA TẦNG**  
(LOẠI VẬT LIỆU INOX KHÁCH HÀNG TÙY CHỌN)



HS - 3A

HS - 3B

HS - 3C

HS - 3D



HS - 4A

HS - 4B

HS - 4C

HS - 4D

**GHI CHÚ:** INOX SỌC NHUYỄN / INOX GƯƠNG => Màu trắng, màu vàng, màu đồng  
(Inox màu nào ăn mòn màu đó)  
\* Phần màu xám là vật liệu  
\* Phần màu trắng là vị trí ăn mòn



**MẪU HOA VĂN CỬA TẦNG**  
(LOẠI VẬT LIỆU INOX KHÁCH HÀNG TÙY CHỌN)



HS - 5A

HS - 5B

HS - 5C

HS - 5D



HS - 6A

HS - 6B

HS - 6C

HS - 6D

**GHI CHÚ:** INOX SỌC NHUYỄN / INOX GƯƠNG => Màu trắng, màu vàng, màu đồng  
(Inox màu nào ăn mòn màu đó)  
\* Phần màu xám là vật liệu  
\* Phần màu trắng là vị trí ăn mòn

**MẪU HOA VĂN CỬA TẦNG**  
(LOẠI VẬT LIỆU INOX KHÁCH HÀNG TÙY CHỌN)

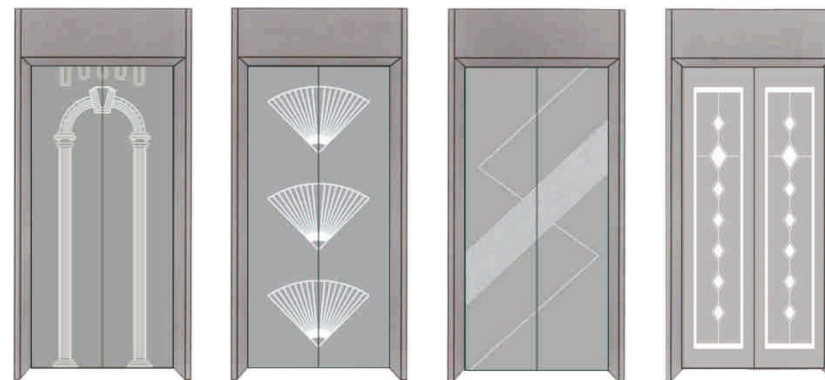

HS - 7A

HS - 7B

HS - 7C

HS - 7D



HS - 8A

HS - 8B

HS - 8C

HS - 8D

**GHI CHÚ:** INOX SỌC NHUYỄN / INOX GƯƠNG => Màu trắng, màu vàng, màu đồng  
(Inox màu nào ăn mòn màu đó)  
\* Phần màu xám là vật liệu  
\* Phần màu trắng là vị trí ăn mòn



**MẪU HOA VĂN CỬA TẦNG**  
(LOẠI VẬT LIỆU INOX KHÁCH HÀNG TÙY CHỌN)

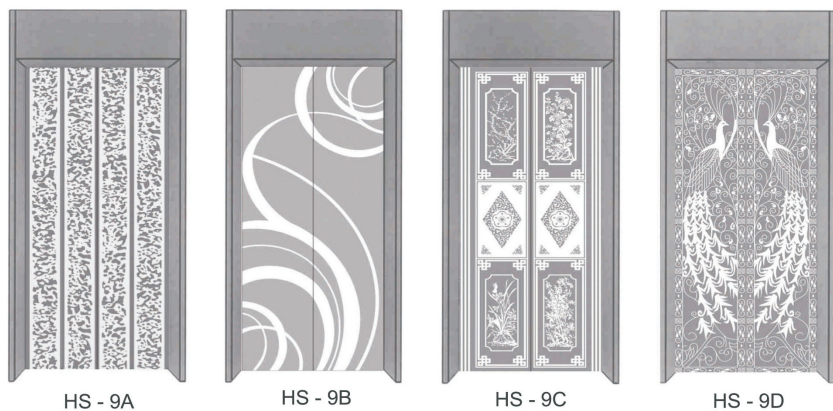

HS - 9A

HS - 9B

HS - 9C

HS - 9D

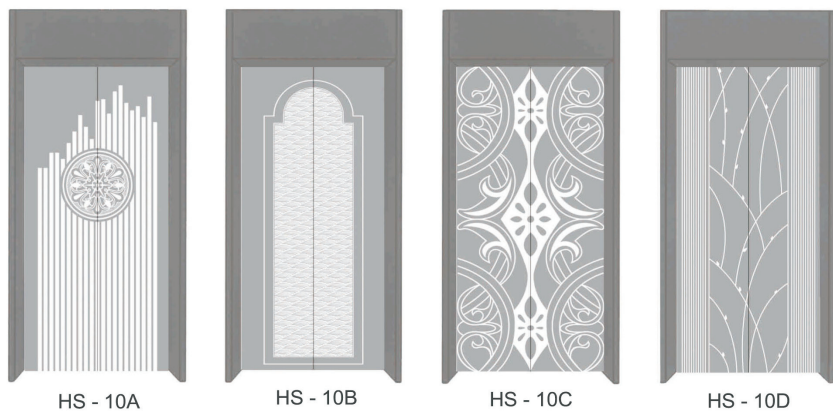

HS - 10A

HS - 10B

HS - 10C

HS - 10D

**GHI CHÚ:** INOX SỌC NHUYỄN / INOX GƯƠNG => Màu trắng, màu vàng, màu đồng  
(Inox màu nào ẩn mòm màu đó)  
\* Phần màu xám là vật liệu  
\* Phần màu trắng là vị trí ẩn mòm

**MẪU HOA VĂN CỬA TẦNG**  
(LOẠI VẬT LIỆU INOX KHÁCH HÀNG TÙY CHỌN)

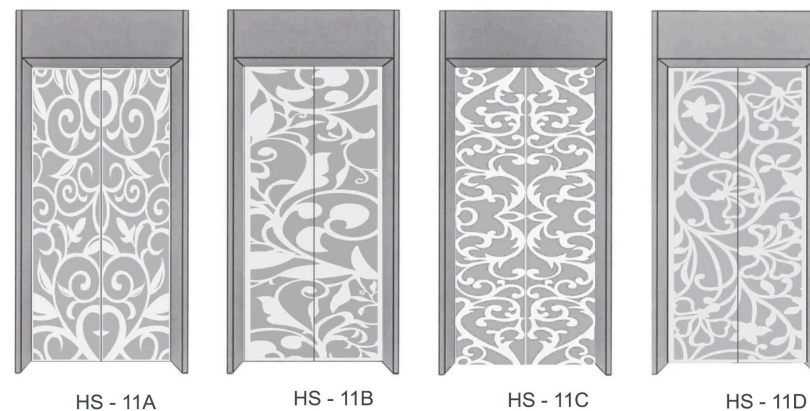

HS - 11A

HS - 11B

HS - 11C

HS - 11D



HS - 12A

HS - 12B

HS - 12C

HS - 12D

**GHI CHÚ:** INOX SỌC NHUYỄN / INOX GƯƠNG => Màu trắng, màu vàng, màu đồng  
(Inox màu nào ẩn mòm màu đó)  
\* Phần màu xám là vật liệu  
\* Phần màu trắng là vị trí ẩn mòm



**MẪU HOA VĂN CỬA TẦNG**  
(LOẠI VẬT LIỆU INOX KHÁCH HÀNG TÙY CHỌN)

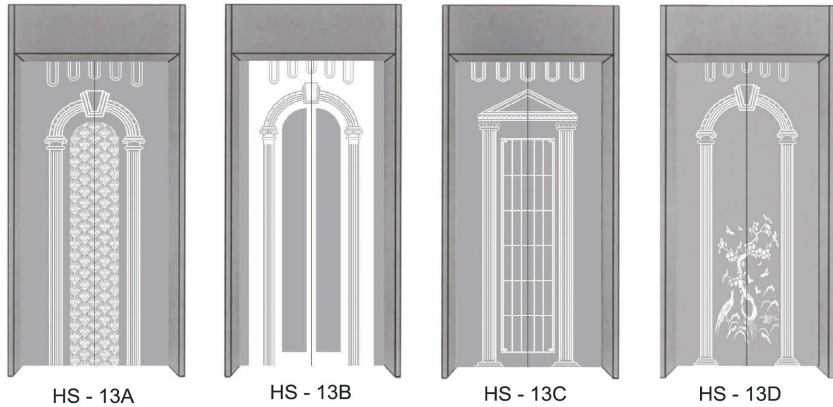

HS - 13A

HS - 13B

HS - 13C

HS - 13D



HS - 14A

HS - 14B

HS - 14C

HS - 14D

**GHI CHÚ:** INOX SỌC NHUYỄN / INOX GƯƠNG => Màu trắng, màu vàng, màu đồng  
(Inox màu nào ăn mòn màu đó)  
\* Phần màu xám là vật liệu  
\* Phần màu trắng là vị trí ăn mòn

**MẪU HOA VĂN CỬA TẦNG**  
(LOẠI VẬT LIỆU INOX KHÁCH HÀNG TÙY CHỌN)

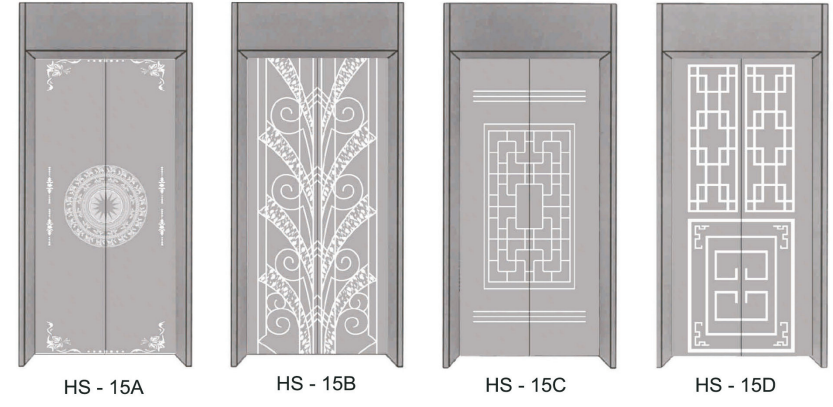

HS - 15A

HS - 15B

HS - 15C

HS - 15D

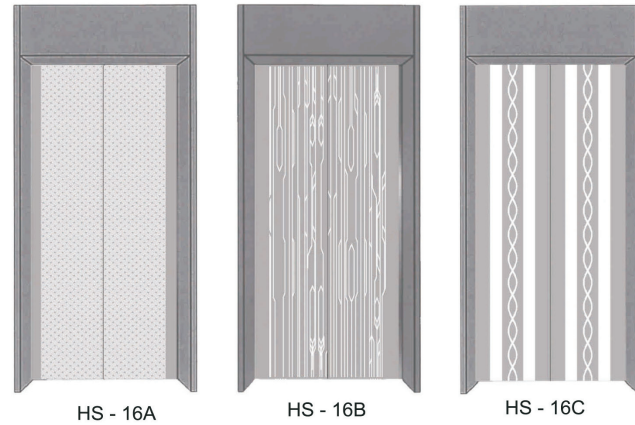

HS - 16A

HS - 16B

HS - 16C

**GHI CHÚ:** INOX SỌC NHUYỄN / INOX GƯƠNG => Màu trắng, màu vàng, màu đồng  
(Inox màu nào ăn mòn màu đó)  
\* Phần màu xám là vật liệu  
\* Phần màu trắng là vị trí ăn mòn

Hotline: 0352 298 822

Hotline: 0352 298 822





Khung bản rộng vát 02 chiều  
Cửa mở tim: inox gương trắng



Khung bản rộng vát 03 chiều  
Cửa mở tim: inox gương vàng



Bản rộng vát 02 chiều tấm trắng cao  
Cửa mở tim: inox gương đồng



Khung bao rộng, vát ba chiều  
Cửa mở tim: Inox gương đen



Khung bản rộng vát 03 chiều  
Cửa mở tim: inox sọc vàng



Khung bản rộng vát 03 chiều  
Cửa mở tim: inox sọc đồng



Khung bản hẹp  
Cửa mở tim: inox gương đen



Cửa kính cường lực mở tim



Cửa kính cường lực mở tim

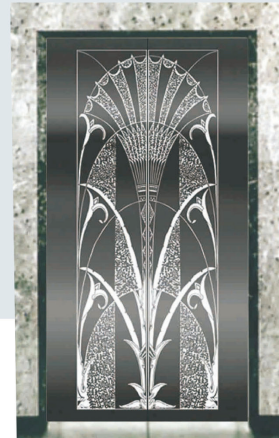

Khung bản hẹp  
Cửa mở tim: inox sọc đen



Cửa lùa về 1 phía  
inox gương ăn mòn hoa văn



Cửa lùa về 1 phía  
kính cường lực



SÀN CABIN ĐÁ GRANITE



Hồng Gia Lai



Đỏ Ruby Ấn Độ

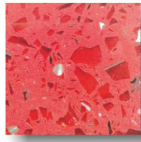

Đỏ Nhân Tạo



Trắng Bình Định  
(Núi Le)



Vàng Bình Định

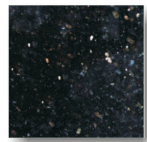

Đen kim sa

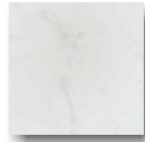

Trắng Vân Mây



Xanh Napoli Ý



Đá ghép: Trắng sứ viền đen

SÀN CABIN ĐÁ HOA VĂN



HS - GS001  
1000x1000  
1000x1200  
1200x1200



HS - GS002  
1000x1000  
1000x1200  
1200x1200



HS - GS003  
1000x1000  
1000x1200  
1200x1200



HS - GS004-1.0  
1000x1000  
1000x1200



HS - GS004-1.2  
1200x1200



HS - GS005  
1000x1000  
1000x1200



HS - GS006  
1000x1000



HS - GS007  
800x1200

**GHI CHÚ:** Kiểu đá hoa văn và màu sắc có thể thay đổi một ít theo từng đợt nhập hàng

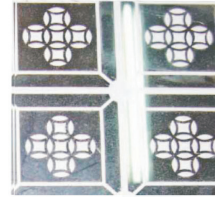

HS-CW001

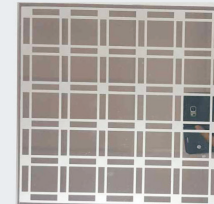

HS-CW002

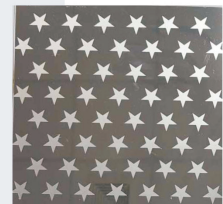

HS-CW003

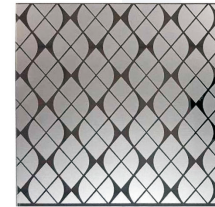

HS-CW004

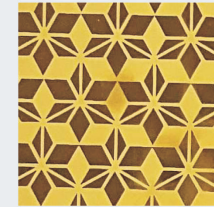

HS-CWN005

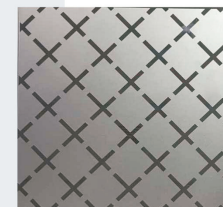

HS-CW006

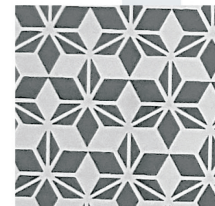

HS-CWN007

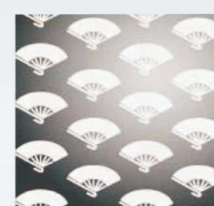

HS-CW008



HS-CWN009

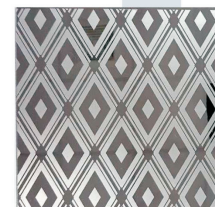

HS-CW010



HS-CWN011

## MẪU LAMINATE



B105



B108



C103

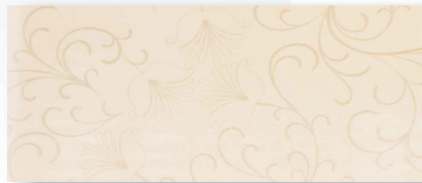

WH 152

Hotline: 0352 298 822

## MẪU TRẦN GIẢ

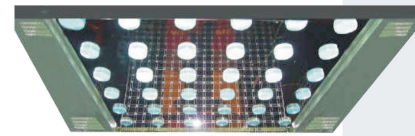

HS-TA001

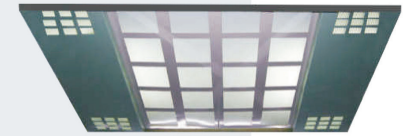

HS-TA002



HS-TA003

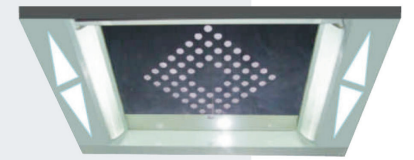

HS-TA004

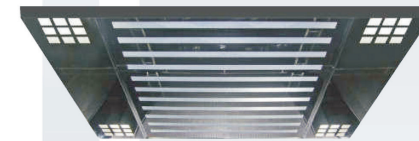

HS-TA005



HS-PV001

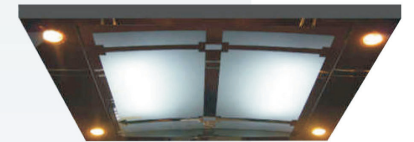

HS-PV002



HS-PV003



HS-PV004

**CHÚ Ý:** Mẫu HS-TA006 đã hủy, không còn sản xuất nữa

Hotline: 0352 298 822



## MẪU TRẦN GIẢ



HS - PV005



HS - PV006



HS - PV007

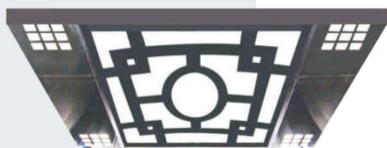

HS - PV008



HS - PV009



HS - PV010



HS - PV011

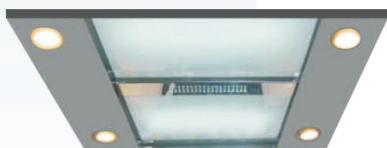

HS - PV012

## MẪU TRẦN GIẢ



HS - PV013



HS - PV014



HS - PV015



HS - PV016



HS - PV017



HS - PV018



HS - PV019



HS - PV020

**VẬT LIỆU: Inox gương / sọc, màu trắng / vàng**

MẪU TRẦN GIẢ



HS - PV021



HS - PV022

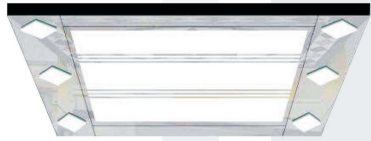

HS - PV023



HS - PV024



HS - PV025



HS - PV026



HS - PV027



HS - PV028

VẬT LIỆU: Inox gương / sọc, màu trắng / vàng

MẪU TRẦN GIẢ



HS - PV029



HS - PV030

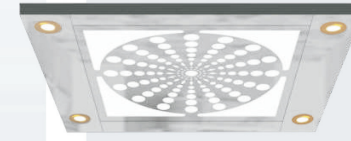

HS - PV032



HS - PV033



HS - PV034



HS - PV035



HS - PV036

VẬT LIỆU: Inox gương / sọc, màu trắng / vàng

CHÚ Ý: Mẫu HS-PV031 đã hủy, không còn sản xuất nữa

Hotline: 0352 298 822

Hotline: 0352 298 822



## MẪU TRẦN GIẢ



HS - PV037



HS - PV038

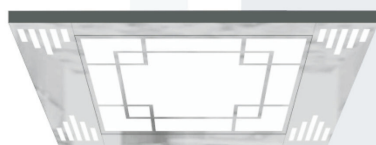

HS - PV039

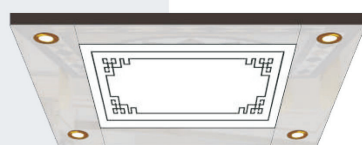

HS - PV048



HS - PV049



HS - PV050

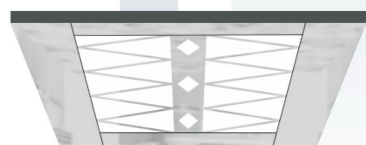

HS - PV051

VẬT LIỆU: Inox gương / sọc, màu trắng / vàng

## MẪU TRẦN GIẢ DÁN DECAL

### INOX GƯƠNG TRẮNG (SỌC TRẮNG)



HS - PV040



HS - PV041



HS - PV042

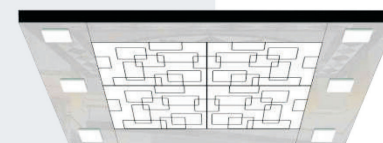

HS - PV045



HS - PV046



HS - PV047



HS - CGU11



HS - CGU14



HS - CGU16



HS - CGU19



## BUTTON CABIN

Nút nhấn và hiển thị tùy chọn



## BUTTON CABIN

Nút nhấn và hiển thị tùy chọn



Hotline: 0352 298 822



HS - BT01



HS - BT02



HS - BT03



HS - BT04



HS - BT05



HS - BT06



HS - BT07



HS - BT08



HS - BT09

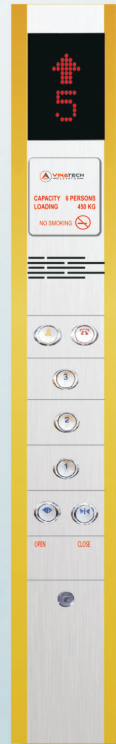

HS - BT10

Hotline: 0352 298 822



## BUTTON CABIN VÀ TẦNG

Nút nhấn được bao gồm theo mẫu nhập



COP630

CEC260

COP08

COP1020B

Hotline: 0352 298 822

## BUTTON CABIN VÀ TẦNG

Nút nhấn được bao gồm theo mẫu nhập



HS-FB01

HS-FB02

HS-FB03

HS-FB04

HS-FB05

HS-FB06



HS-FB07

HS-FB08

HS-FB09

HS-FB10

EH 1020B

LOP08

Hotline: 0352 298 822

## BUTTON TẦNG KHÔNG HỘP ÂM

Nút nhấn đồng bộ theo button



LSC260



LSC260(LCD)



BXG262

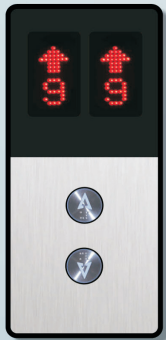

Duplex BBG262

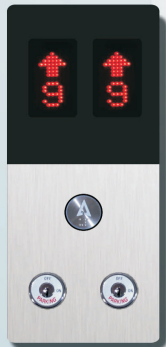

Duplex DSC260S

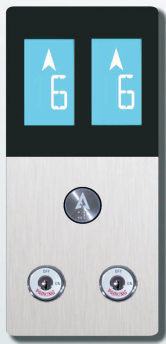

Duplex DSC260S  
(LCD)

**Chú ý:-** Các Button tầng không hộp âm chỉ dùng được board Step và nút nhấn PB31  
- Button tầng BXG262 dùng được board Step hoặc Nippon

## MẪU TAY VỊN CABIN



HS - H001



HS - H002 (Laminate)



HS - H003



HS - H006 (gỗ)



HS - H003G

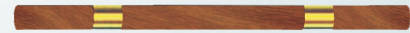

HS - H007 (gỗ)



HS - 3H003



HS - H004



HS - 3H003G



HS - H004G

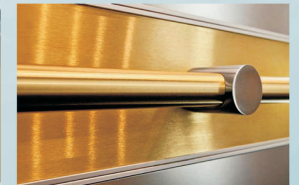
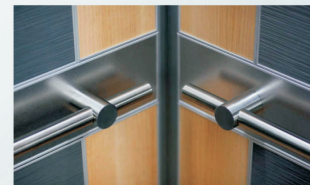



## MẪU NÚT NHẤN



<p>VUÔNG TQ</p>	<p>LA 3024</p>	<p>3929</p>
<p>VUÔNG BT3328S</p>	<p>PB 31</p>	<p>BQ</p>
<p>EBR-01</p>	<p>BA 530 (BA53N)</p>	<p>BA 531</p>
<p>OVAL EMR100</p>	<p>OVAL TWS</p>	<p>EB 410 (EB 111)</p>
<p>35CA-B</p>	<p>35CCO</p>	

## MẪU HIỂN THỊ LCD



### HIỂN THỊ LCD CABIN

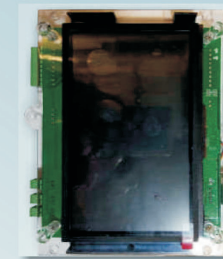
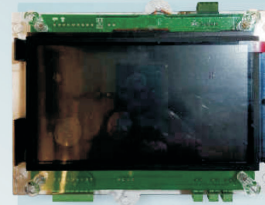

CFC-2402-P \_ 7"

### HIỂN THỊ LCD TẦNG

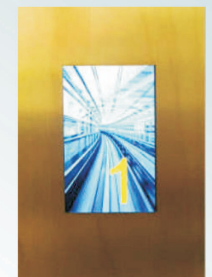

CFH-2401-P \_ 4.3"

## CÁC LOẠI HỆ ĐIỀU KHIỂN VÀ BIẾN TẦN (VVVF)

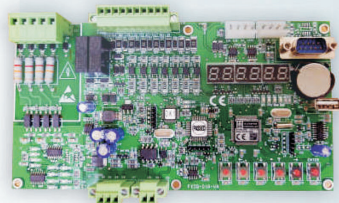

Bộ vi xử lý FX3G

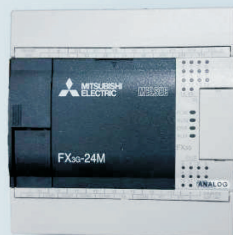

PLC - Mitsubishi (Nhật Bản)

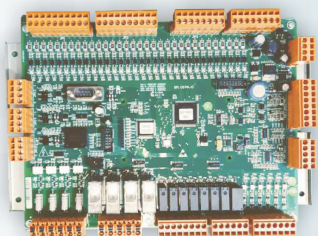

Bộ vi xử lý STEP F5021

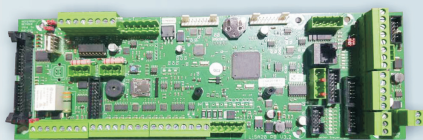

Bộ vi xử lý LISA20 (DLR LISA20 PB)



VVVF:FUJI - JAPAN (Nhật Bản)  
(Loại chuyên dùng cho thang máy)



VVVF:YASKAWA - JAPAN (Nhật Bản)  
(Loại chuyên dùng cho thang máy)



VVVF:ZEIHL ABEGG- GERMANY (ĐỨC)  
(Loại chuyên dùng cho thang máy)

## CÁC LOẠI TỦ ĐIỆN ĐIỀU KHIỂN



TỦ ĐIỆN PLC FX3G + VVVF YASKAWA



TỦ ĐIỆN NIPPON - NICE 3000



## CÁC LOẠI TỦ ĐIỆN ĐIỀU KHIỂN



TỦ ĐIỆN BOARD STEP F5021 + VVVF FUJI



TỦ ĐIỆN STEP - THAILAND

## CÁC LOẠI TỦ ĐIỆN ĐIỀU KHIỂN



TỦ ĐIỆN FUJI JAPAN



TỦ ĐIỆN FUJI - MALAYSIA



TỦ CỨU HỘ (ARD)

Hotline: 0352 298 822

Hotline: 0352 298 822

## CÁC LOẠI MÁY KÉO



### MÁY KÉO MONTANARI, SẢN XUẤT TẠI Ý



MGX75



MGV25S



MGX80

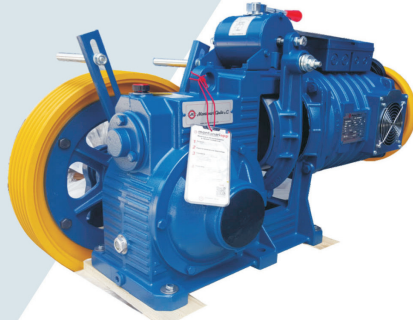

M75S

### MÁY KÉO FUJI SẢN XUẤT TẠI MALAYSIA

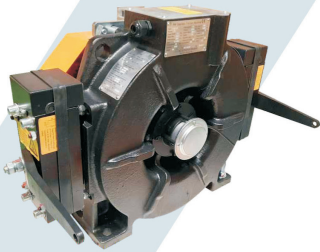

FJD1-B 3.3KW



FJD1-B 4.2KW - 8.0 KW

## CÁC LOẠI MÁY KÉO



### MÁY KÉO NIPPON SẢN XUẤT TẠI MALAYSIA



FJD1 3.3KW



FJD1 4.2KW - 8.0 KW

### MÁY KÉO TORIN CÔNG NGHỆ MỸ, SẢN XUẤT TẠI TRUNG QUỐC



GTW7A



GTW9S



GTW10

### MÁY KÉO FUJI JAPAN, SẢN XUẤT TẠI NHẬT BẢN



FJG7 3.3KW-6.2KW



FJG7 4.1KW

Hotline: 0352 298 822

Hotline: 0352 298 822



## CÁC LOẠI MÁY KÉO



### MÁY KÉO ZIEHL ABEGG SẢN XUẤT TẠI ĐỨC



SM190.15



SM200.15D



SM200.23D



SM200.40D (SM200.40E)

Hotline: 0352 298 822

## CÁC PHỤ KIỆN



Ty Treo cáp

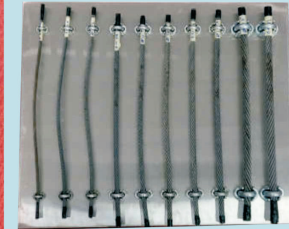

Cáp tải  
6.5, 8, 10, 12, 16



Xích bù



Giảm chấn đối trọng / Cabin



Giảm chấn  
khung chân máy kéo



Giảm chấn sàn Cabin



Shoe dẫn hướng đối trọng / Cabin

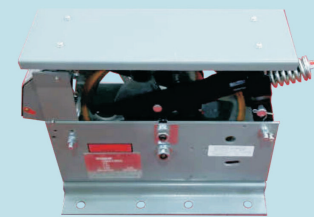
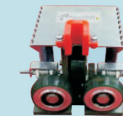

Bộ chống vượt tốc ( Governor )

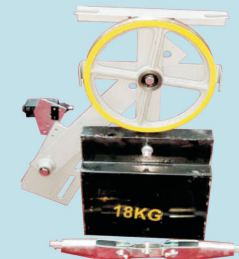

Hotline: 0352 298 822





Kho hàng



Kho máy kéo số lượng lớn

Hotline: 0352 298 822

Hotline: 0352 298 822

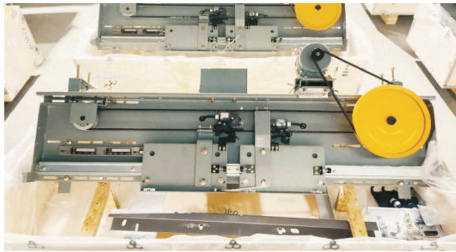

Đầu cửa cabin

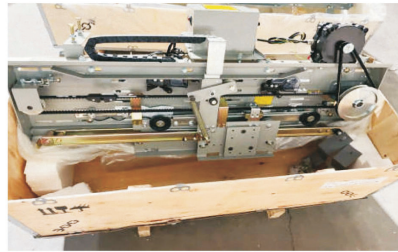

Đầu cửa tầng



Thanh rail



Cảm quang cửa (Photocell nguyên thanh)



Cáp điện di chuyển theo Cabin (Cordon)



Cáp kéo Korea - Italy



